

CHAPTER 1

FUNDAMENTALS OF COMPUTER

SHORT AND LONG QUESTIONS

Q.1 Briefly describe the working of computer processing system.

Ans: Working of Computer processing system:

A computer is a general-purpose programmable machine.

Computer:

Computer is an advanced electronic device that takes raw data as input from the user and processes it under the control of set of instructions (called program), gives the result (output), and saves it for the future use.

Function of Computer:

Computer has the ability to store, retrieve and process data. It processes data at very high speed according to the instructions given to it and produces accurate results.

Computer program:

The instructions given to a computer to perform a particular task is known as computer program. Computer processing system is shown in Fig.

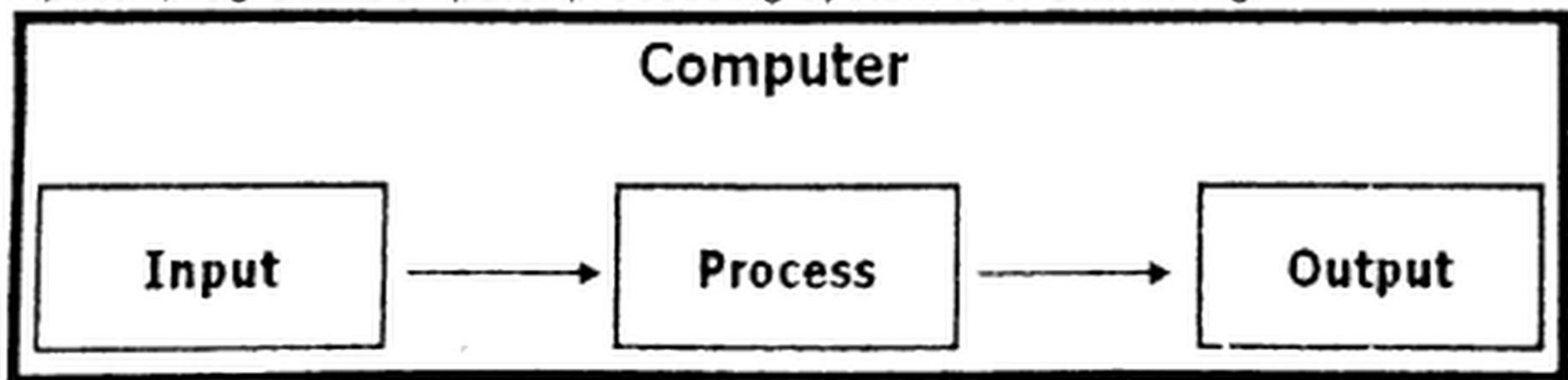

Computer processing system

Q.2 Highlight various stages in evolution of computers.

Ans: Evolution of Computer:

Evolution of computers means how the computers evolved from the first mechanical device, abacus, to electromechanical and then to the modern electronic digital computers.

Q.3 What are the tasks performed by Abacus?

Ans: Abacus:

Visit : <https://ruff.pk>

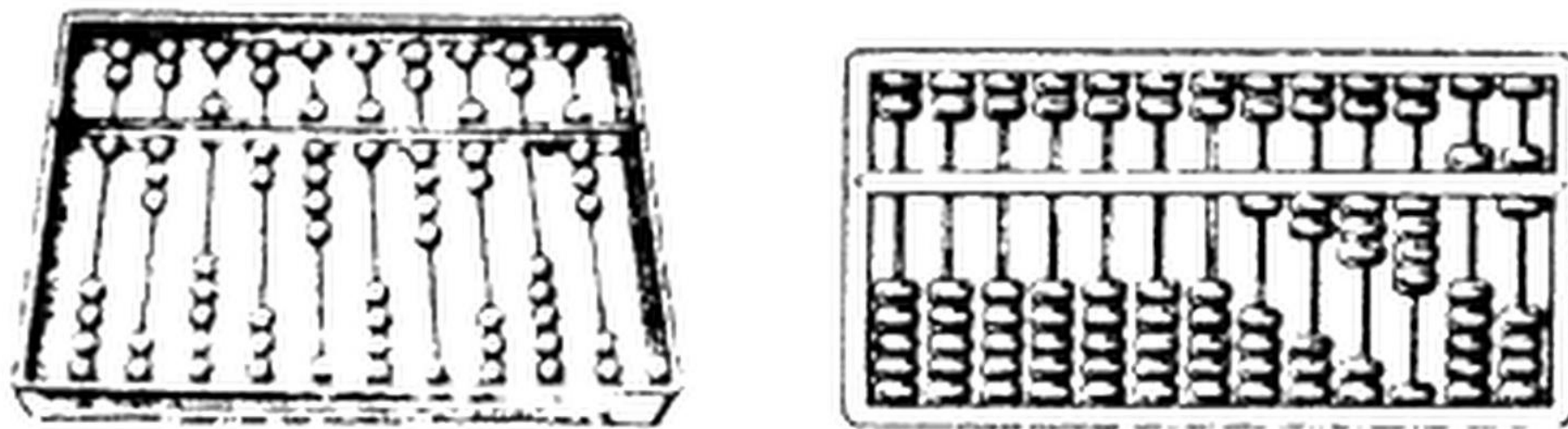

Abacus

These rods had a number of wooden beads which could slide freely along the length of rods. While performing calculations, beads were moved up and down with fingers.

Tasks performed by Abacus:

Abacus was used to perform addition, subtraction, multiplication and division. It has been used in China and some other Asian countries till the end of 20th century.

Titbits

Abacus is still seen at some toy shops, made of plastic or wood for small children.

Q.4 What are the tasks performed by Pascaline?

Ans: Pascaline:

Blaise Pascal, a French mathematician invented a calculating machine called Pascaline in 1642 when he was only 19 years old.

Construction:

Pascaline used rotating wheels. Each wheel had ten parts having digits from 0 to 9. Calculations were performed by the rotation of wheels. When one wheel completes a rotation, the next wheel moves by one digit. It had a number of small slots for displaying the result.

Tasks performed by Pascaline:

Pascaline could perform addition and subtraction on whole numbers.

Slots to display Results

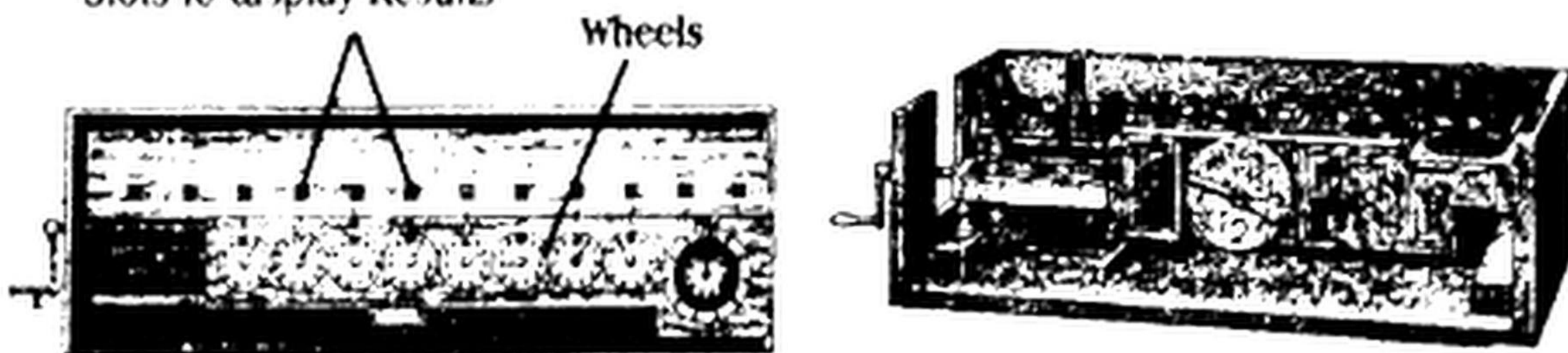

Pascaline

Q.5 Differentiate between Difference Engine and Analytical Engine.

Ans: Difference Engine:

In 1822, the English mathematician Charles Babbage started working on a big calculating machine about the size of a room. He called it Difference Engine.

Analytical Engine:

Today's modern digital computers are based on the idea of analytical engine.

Father of modern digital computers:

Charles Babbage is known as the father of modern digital computers.

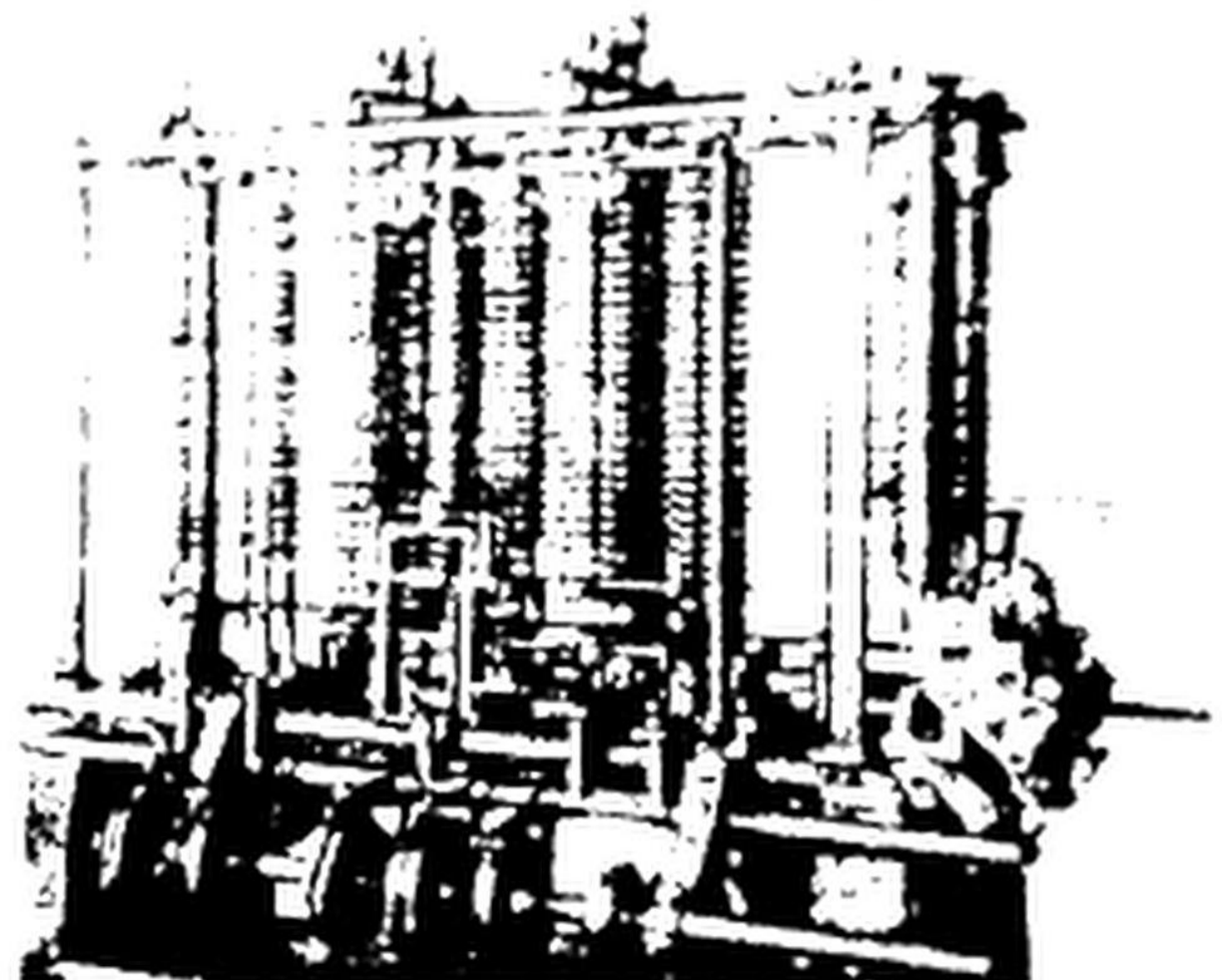
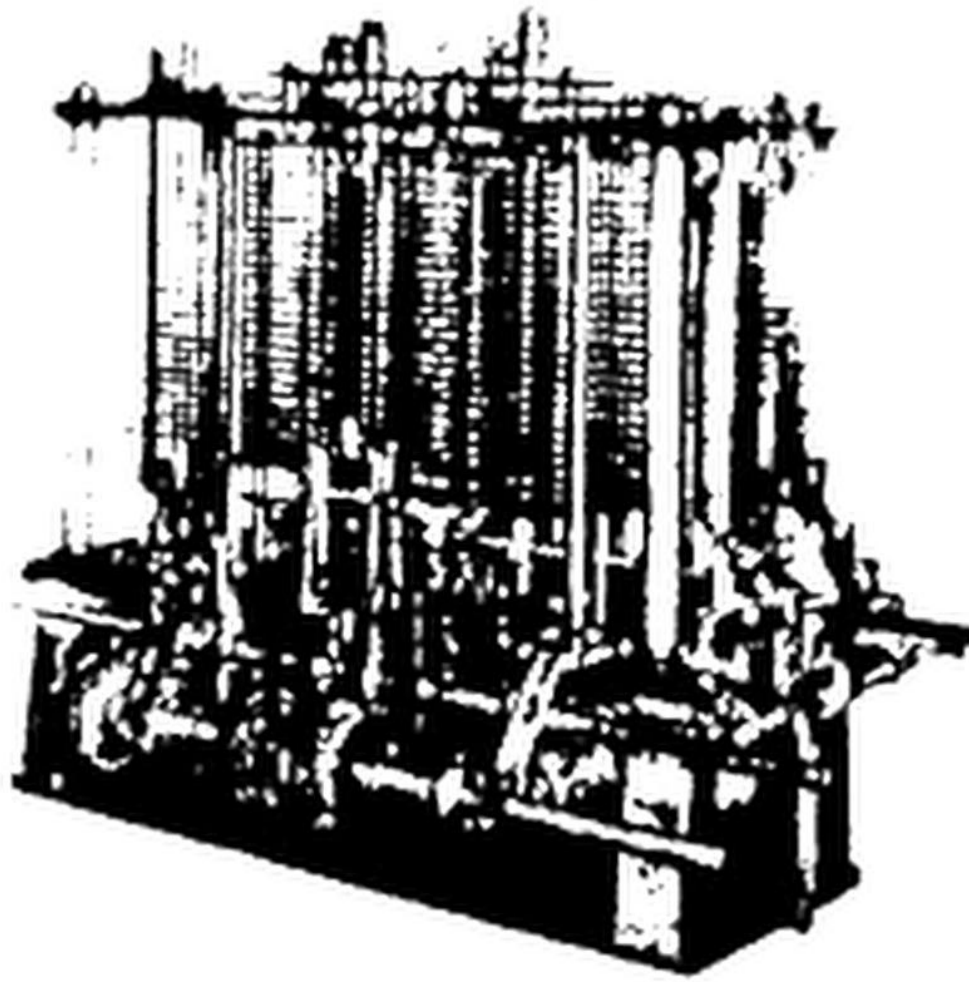

Analytical Engine

Q.6 Write a note on Hollerith desk.

Ans: Hollerith Desk:

In 1890, Herman Hollerith built a tabulating machine called Hollerith Desk. This machine was invented to help with the census of 1890 in America.

Construction:

Hollerith Desk consisted of a card reader which sensed the holes in the cards, a gear driven mechanism which could count and a large set of dial indicators to display the results.

After building Hollerith Desk, Hollerith started a company by the name of Tabulating Machine Company. Eventually this company changed its name to International Business Machines (IBM).

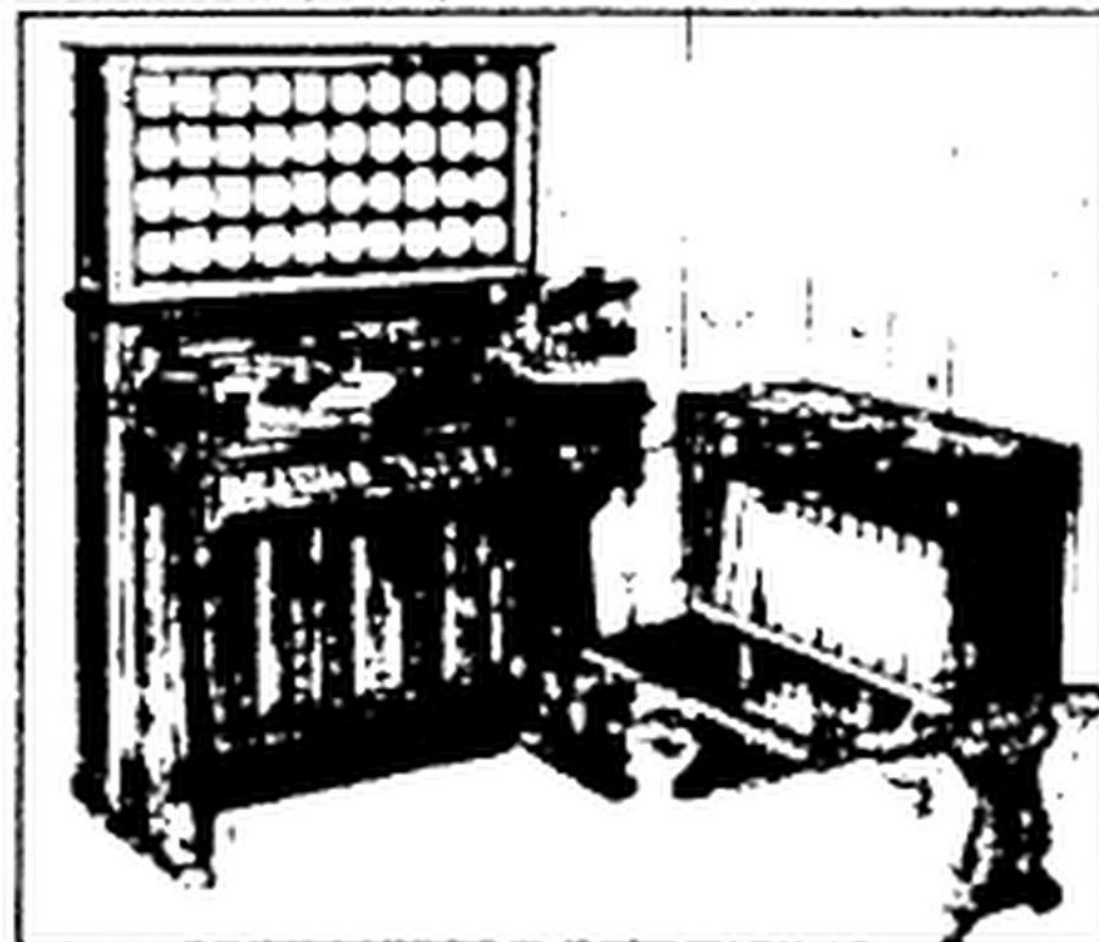

Hollerith Desk

Q.7 What are the various tasks performed by Mark-I ?

Ans. Mark-I:

Tasks performed by Mark-I:

Mark-I could add three numbers having eight digits in one second. It could print out its results on punched cards or on an electric typewriter.

Size of Mark-I:

Mark-I was 50 feet long, 8 feet high and weighed about 5 tons.

Technology used in Mark-I:

It used 3,000 electric switches.



Mark - I Computer

Q.8 Justify the statement that computer evolution is a continuous process.

Ans: Since computer evolution is a continuous process, it has not stopped in the modern era. New systems are being developed to provide voice recognition and understand natural languages.

High performance computing (HPC):

High performance computing (HPC) is being used in today's data centers for fast data processing. High-performance computing (HPC) is the use of parallel processing for running advanced application programs efficiently, reliably and fast.

Cloud Computing:

The concept of "Cloud Computing" has been introduced. In the simplest terms, cloud computing means storing and accessing data and programs over the Internet instead of computer's hard drive.

Current advancements:

The current advancements in computer technology are likely to transform computer into intelligent machine having thinking power. The evolution of computers will probably continue till their processing capabilities have become equal to human intelligence or even beyond that.

Q.9 List history and generations of computer.

Ans: History and Generations of Computer:

History of computers is a chain that runs from the ancient abacus and the

Q.10 Write a short note on the second generation of computer and the technology used in it. Also write down the names of model used in second generation of computers?

OR

Write a note on invention of transistor and second-generation of computers?

Ans: Second Generation Computers (1956 – 1963):

In 1947, three scientists, William Shockley, John Bardeen and Walter Brattain invented transistor.

Transistor:

Transistor functions like a vacuum tube. It replaced the vacuum tubes in the second generation computers. Transistor was faster, more reliable, smaller and much cheaper than vacuum tube.

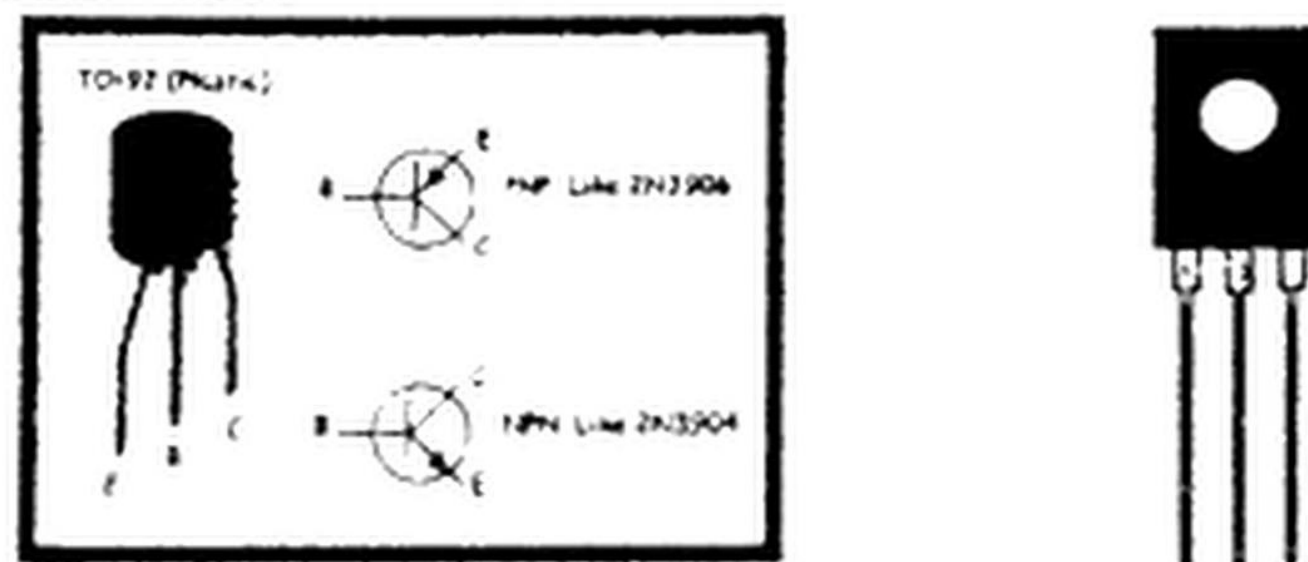

Transistor

Characteristics/Features of second generation computers:

The following are the characteristics of second generation computers.

- i. Transistors were used instead of vacuum tubes.
- ii. Transistors reduced the size of computers and increased the speed and memory capacity.
- iii. Computers became more reliable and cheaper.
- iv. Second generation computers used punch card readers, magnetic tapes, magnetic disks and printers.
- v. Assembly language was used in these computers.
- vi. High level programming languages, FORTRAN and COBOL were introduced in this generation of computers.

Models/examples:

Examples of second generation computers are UNIVAC II, IBM 7030, 7780 and 7090, NCR 300 series, General Electric GE 635 and Control Data Corporation's CDC 1604 computers.

Q.11 Write a short note on the Fourth generation of computer and the technology used in it. Also write down the names of model used in Fourth generation of computers?

OR

Write a note on invention of Microprocessor and Fourth -generation of computers?

Microprocessor was also developed in fourth generation of computers. A microprocessor is a single chip that can handle all the processing of a computer. A microprocessor is shown in Fig.

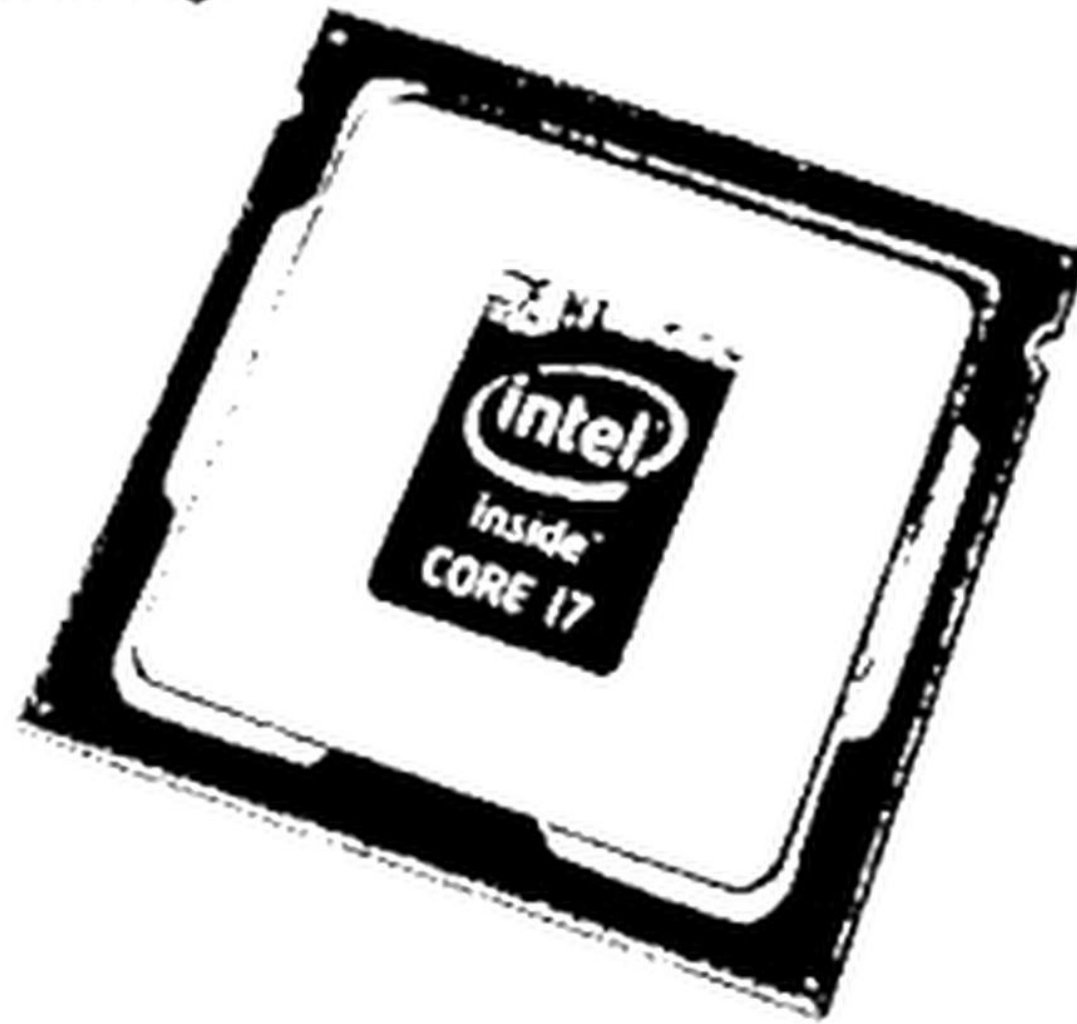

Microprocessor

Characteristics/features of fourth generation computers:

The following are the characteristics of fourth generation of computers.

- i.** Microprocessor was developed which resulted in the development of microcomputers.
- ii.** Fourth generation computers are very fast, have large storage capacity and use advanced input/output devices.
- iii.** Microcomputers are very small in size, very reliable, consume less power and are affordable.
- iv.** Large variety of software is available for use in microcomputers.
- v.** Operating system having Graphical User Interface (GUI) was developed in this generation.
- vi.** These computers support multimedia software that combines text, image, sound and video.
- vii.** These computers support modern programming languages such as Visual Basic, C++, Java and Python for developing powerful software.
- viii.** Fourth generation computers support a large variety of portable and wireless input/output devices.

Examples of microprocessors:

Some examples of microprocessors developed in fourth generation of computers are Intel Pentium series, Dual Core, Core2 Duo, Core i3, i5, i7 and AMD Athlon.

Examples of fourth generation computers:

Some examples of fourth generation computers are IBM Think Pad series, HP Pavilion series, Dell Inspiron series and Apple's MacBook Pro and MacBook Air series.

Q.12 Write a short note on the fifth generation of computer and the technology used in it. Also write down the names of model used in fifth generation of computers?

OR

Write a note on Artificial Intelligence and fifth -generation of computers?

Ans: Fifth Generation Computers:

The goal of fifth generation of computers is to develop devices that can understand natural languages and have thinking power. This is a big challenge for computer developers and programmers to design such systems and software for them

Characteristics/features of fifth generation computers:

The following are the characteristics of fifth generation of computers.

- i. Fifth generation computers are based on Artificial Intelligence (AI).
- ii. In the fifth generation of computers, Artificial Intelligence (AI) will minimize the need to write programs.
- iii. These computers will allow users to give commands in any natural language such as English

Examples of fifth generation computers:

Examples of fifth generation computers are robots and expert systems.

For Your Information

Artificial Intelligence is the branch of computer science concerned with making computer behave like humans

Q.13 List the TYPES/classification OF COMPUTERS.

Ans: Types of Computers:

On the basis of data representation, processing, Input and Output, Computers can be classified into the following three types.

- i. Analog Computers
- ii. Digital Computers
- iii. Hybrid Computers

Q.14 Describe some of the features of Hybrid Computers/ Vital Sign Monitoring Unit.

Ans: Hybrid Computers/Vital Sign Monitoring Unit:

Hybrid computers are the combination of analog and digital computers. They combine the characteristics of both analog and digital computers.

Uses of Hybrid Computers:

Hybrid computers are mainly used for scientific applications. These computers are used in spaceships, missile systems, scientific research, hospitals and for controlling industrial processes.

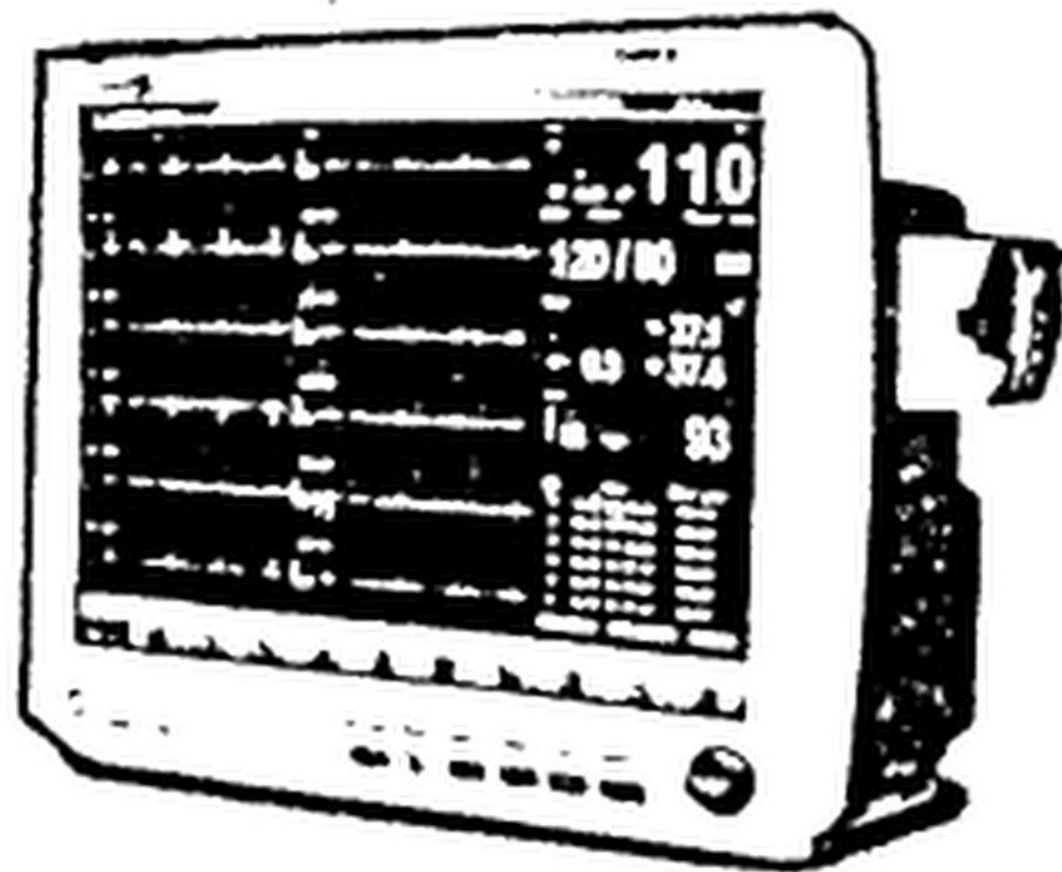

A Hybrid Computer (Vital Sign Monitoring Unit)

Q.15 List the classification of digital computers.

Ans: Classification of Digital Computers:

Digital computers are classified into mainframe, minicomputer and microcomputer based on their size, speed, storage capacity and the number of users they can support

Q.16 List the use/Role of computers in education.

Ans: Education:

Role of computers in education has been given a lot of importance in the recent years. Computer technology eases the process of learning. Many programs are available for students to learn the subjects of Physics, Mathematics, Chemistry, Biology, etc.

Multimedia software makes the process of learning interactive and interesting. It combines text, graphics, sound and video for effective learning. Internet has enormous information on a wide variety of subjects. Students can refer to Internet to find information on any topic.

Multimedia projectors:

Nowadays computers with multimedia projectors are being used in classrooms for effective teaching. All the activities related to examinations are also being controlled using computers. Therefore, it plays an important role in education. Today, computer education is a part of curricula from elementary to university level.

Q.17 Discuss the use/Role of computers in education.

Ans: Business:

Computers are used in all types of businesses, to improve productivity. They help in running business activities efficiently. They are used to prepare business documents, reports, charts, presentations, invoices, etc. They help in staying in contact with employees and customers.

Important business areas where computers are used:

The following are some important business areas where computers are used.

- i. Computer technology has revolutionized the banking business. Deposits and withdrawals are instantly processed into a customer's account.

iii. **Automated Teller Machine (ATM):**

People can obtain cash any time anywhere through Automated Teller Machine (ATM)

iv. **Bar code readers:**

Computers are used in retail stores. Bar code readers are linked to computer system that are used to read the bar code printed on each product sold to prepare the bill. With the use of computers at retail stores, the checkout process is faster and the bill produced is accurate.

v. **Electronic commerce/E-Commerce:**

Electronic commerce, also known as e-commerce allows to sell products and services by means of computer networks such as Internet.

vi. Computers are very helpful in running many other types of businesses that include hotel, hospital, school, travel agency, real estate, stock exchange, etc.

Q.18 List the Use/Role of Computers in Defense.

Ans: Use/Role of computers in defense:

There are various applications of computer technology in defense. Computers are used in tanks, planes and ships to target enemy forces. They help in tracking missiles and destroying them. Modern defense weapons and other equipment are controlled by computers.

Computers are used for designing and testing of weapons. Computers are also used in communication systems in defense.

Q.19 List the Use/Role of Computers in Media.

Ans: Use/Role of Computers in Media:

Computers have lot of applications in print and electronic media. Print media refers to mass communication through printed material.

Computer technology helps in preparation and production of newspapers, magazines, booklets and brochures, flyers, press releases and books.

Electronic media refers to broadcast media that includes radio broadcast, cable and satellite television broadcast and the new-age media like Internet and mobile devices. Computer is used for television broadcasting.

Q.20 List the Use/Role of Computers in Manufacturing Industry.

Ans: Use/Role of computers in manufacturing industry:

Now days, computer technology is widely used in manufacturing industry. It has improved the accuracy, quality and speed of manufacturing.

Computers are used for product design and automation of manufacturing process in factories. This is known as Computer-Aided Design (CAD) and Computer-Aided Manufacturing (CAM).

Computer-Aided Design (CAD):

CAD involves the use of computer hardware and graphics software to create product designs

Computer-Aided Manufacturing (CAM):

CAM involves the use of computer in planning and management of production operation. It helps in automatically producing finished products.

Q.21 Elaborate the scope of the careers in the field of information technology.

Ans: Careers in Information Technology (IT):

Software Engineer:

Software engineer is a highly skilled person in the field of IT whose responsibilities involve the analysis, design, implementation and maintenance of computer software. Software engineer can be further classified into programmer and system analyst

- **Programmer:**

Computer programmers are IT professionals who have extensive knowledge and expertise in programming languages. They program the computer by writing step-by-step instructions that tell the computer what to do. Computer programmers write programs to solve problems related with business, education, engineering, government offices, hospitals, entertainment, etc

- **System Analyst:**

System analysts analyze the data processing requirements of organizations and develop information systems to implement them. They investigate problems, plan solutions, and recommend the type of hardware and software required for implementing the solution. They also coordinate with the programmers and database administrators in developing information systems.

Hardware Engineer:

Hardware engineers design and manufacture computer hardware. Their work also involves repair and maintenance of computer hardware. They have in-depth knowledge of internal working of computers, processors, circuit boards and other electronic equipment

Network Administrator:

Network administrators are responsible for installation, configuration and maintenance of computer networks in organizations. They are in charge of maintenance of computer hardware and software that make up a computer network. They assign passwords to network users so that unauthorized people do not have access to network

Database Administrator:

Database administrator is a person who is responsible for the design, implementation and maintenance of a database in an organization. He is also responsible for maintaining security and monitoring the performance of database.

Web Designer:

Web designer is a person whose job is to plan and create websites. He designs web pages that include text, images, sound, video clips and make the website interactive. HTML (Hypertext Markup Language) is the most commonly used language for creating websites.

Multimedia Designer:

Multimedia designers are people who organize and present information in an easy to understand and attractive manner. They combine text, graphics, animation

Information Security Analyst:

Information security analyst is a person whose job is to protect information and information systems from unauthorized access, use, modification, recording or destruction. He implements procedures and policies to ensure information security within the organization.

Computer Teacher:

Computer teacher teaches the subject of computer science to students to make them computer literate. He conducts lessons on how to operate computers and the working principles and concepts of computer hardware. He also teaches how to develop computer programs using various programming languages.

Q.22 Define Computer.**Ans: Computer:**

A computer is an electronic data processing device. It reads data processing it and produces results accurately at a very high speed.

Q.23 Define Computer system.**Ans: Computer system:**

A computer along with a number of units attached to it (such as keyboard, monitor, disk drives etc.) is known as a computer system.

Q.24 Differentiate between hardware and software of a computer.**Ans: Difference between computer hardware and software:****Hardware:**

Hardware is a physical device something that you're able to touch and see. Computer hardware refers to the physical components that make up a computer system.

Example:

The computer monitor you're viewing the text on or the mouse you're using to navigate is considered computer hardware. RAM, ROM, motherboard, modem, wireless chip, CPU/Hard Disk etc.

Software:

Computer software is a set of instructions that tells a computer what to do and how to do.

Software is code and instructions that tell a computer or hardware how to operate. This code can be viewed and executed using a computer or other hardware device.

However, without any hardware software would not exist.

Example:

An example of software is Microsoft Windows, an operating system that allows you to control your computer and other programs that run on it.

Another example of software is the Internet browser. Operating system (Windows, Linux) games or applications, word processing /Internet Explorer or Firefox etc. are the examples of software.

Q.25 Write the names of three major units of computer system?

iii. Output units (A monitor, printer etc.)

Q.26 Write the names of hardware components of a computer system?

Ans: Hardware Components of Computer:

Hardware components of a computer system are classified into input devices, system unit, storage devices, output devices and memory.

Q.27 What is the function of input devices.

Ans. Input devices:

All the devices used to feed data into the computer are known as input devices

Function of input devices:

Input devices allow us to communicate with the computer.

Examples:

Some commonly used input devices are keyboard, mouse, microphone, scanner, barcode reader, digital camera and touch screen.

Q.28 Describe the division of keyboard and its functions?

Ans: Keyboard:

It is the main input device to communicate with the computer.

Division of a Keyboard:

It allows the computer user to enter letters, numbers and special symbols into the computer.

Functions of a Keyboard:

A keyboard may be divided into four general areas:-

- | | |
|-------------------------|--------------------------------------|
| i. Alphanumeric keypad. | ii. Numeric keypad. |
| iii. Function keypad. | iv. Screen Navigation & Editing keys |



A Standard Keyboard

Point To Ponder

Why the keys on keyboard are not arranged in alphabetical order?

Ans: In fact, the QWERTY layout was designed to let people type as quickly as possible without jamming a mechanical typewriter. As it happens, this same layout is nearly optimal for pure speed, as it tends to cause the fingers and hands to alternate.

First designs of manual typewriters using keyboards with letters on alphabetical order could not keep up with the speed of fast typist and the QWERTY keyboard layout was designed to reduce jamming.

Q.29 Describe the working and functions of mouse?

Ans: Mouse:

It is a hand-held device used to control the movement of cursor or pointer on the screen. It has two or three buttons at the front that allows the computer user to make selection in menu, draw graphics or open files, folders and programs. A mouse is shown in Fig.



Mouse

Q.30 Describe the working and functions of microphone?

Ans: Microphone:

It is a device that allows computer user to input audio into the computer.

It changes audio signals into electrical signals which are translated into digital form by the sound card for processing in the computer. A microphone is shown in Fig.



Q.31 Describe the working and functions of scanner?

Ans: Scanner:

It is a device that captures images from photographs, magazines, books etc. and stores them in computer in digital form. These images can be edited, displayed on the screen or inserted in documents. A scanner is shown in Fig.



Scanner

Q.32 Describe the working and functions of barcode reader?

Ans: Barcode Reader:

It is a device that reads the barcode printed on products that represents product code, description and price. This information is used by the computer to print bill for the customer. A barcode reader is shown in Fig.



Q.33 Highlight the working and functions of digital camera.

Ans: Digital Camera:

It is a device used to capture pictures and store them in digital form.

These pictures can be downloaded to computer for editing, viewing or inserting in documents. A digital camera is shown in Fig.



Digital Camera

Q.34 Highlight the working and functions of touch screen.

Ans: Touch Screen:

It is a pressure-sensitive display screen that is used to interact with the computer by touching pictures or words with finger. Touch screen is more commonly used with mobile phone and tablet. A touch screen is shown in Fig.

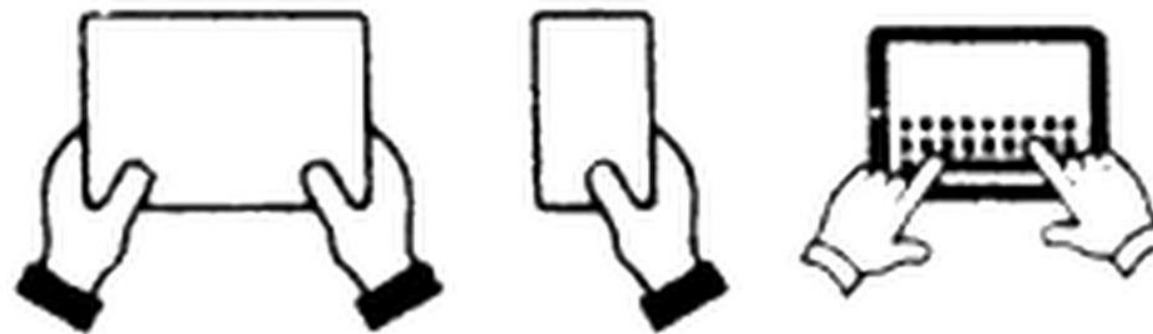

Touch Screen

Q.35 Write the names of three major parts of SYSTEM UNIT ?

Ans: System Unit:

System unit is the main part of computer. It includes motherboard, power supply and drives (such as DVD and hard disk) inside the computer casing. All the input/output devices of a computer are connected to system unit through the ports.

Q.36 Describe the working and structure of motherboard.

Ans. Motherboard:

Motherboard is the main circuit board inside the system unit. It contains microprocessor, main memory, expansion cards, many IC chips, connectors and other electronic components.

It has many buses (electric pathways) printed on it. These are used to transmit information between various components of the computer. All the input/output devices are connected to the motherboard. A motherboard is shown in Fig.

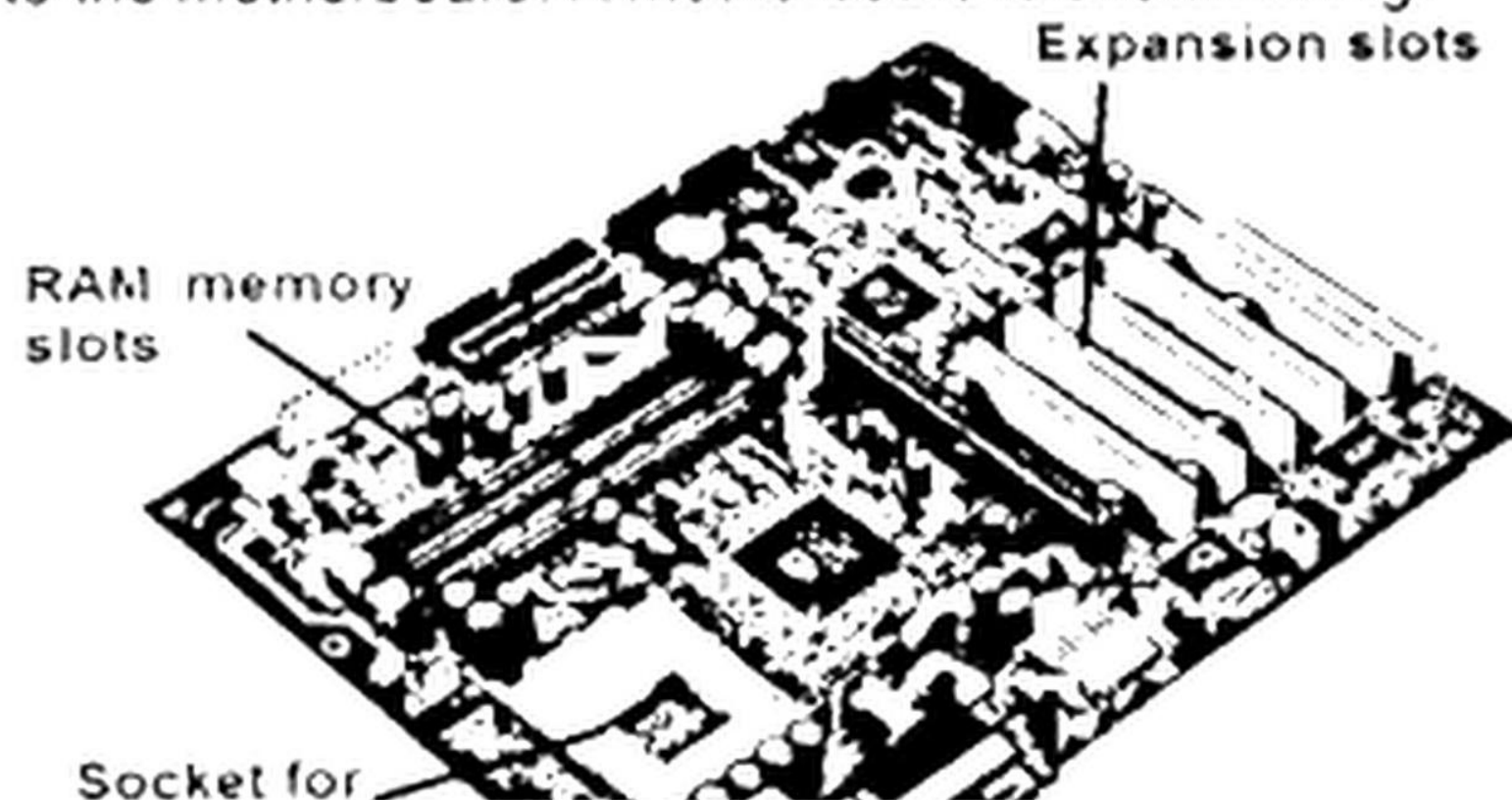

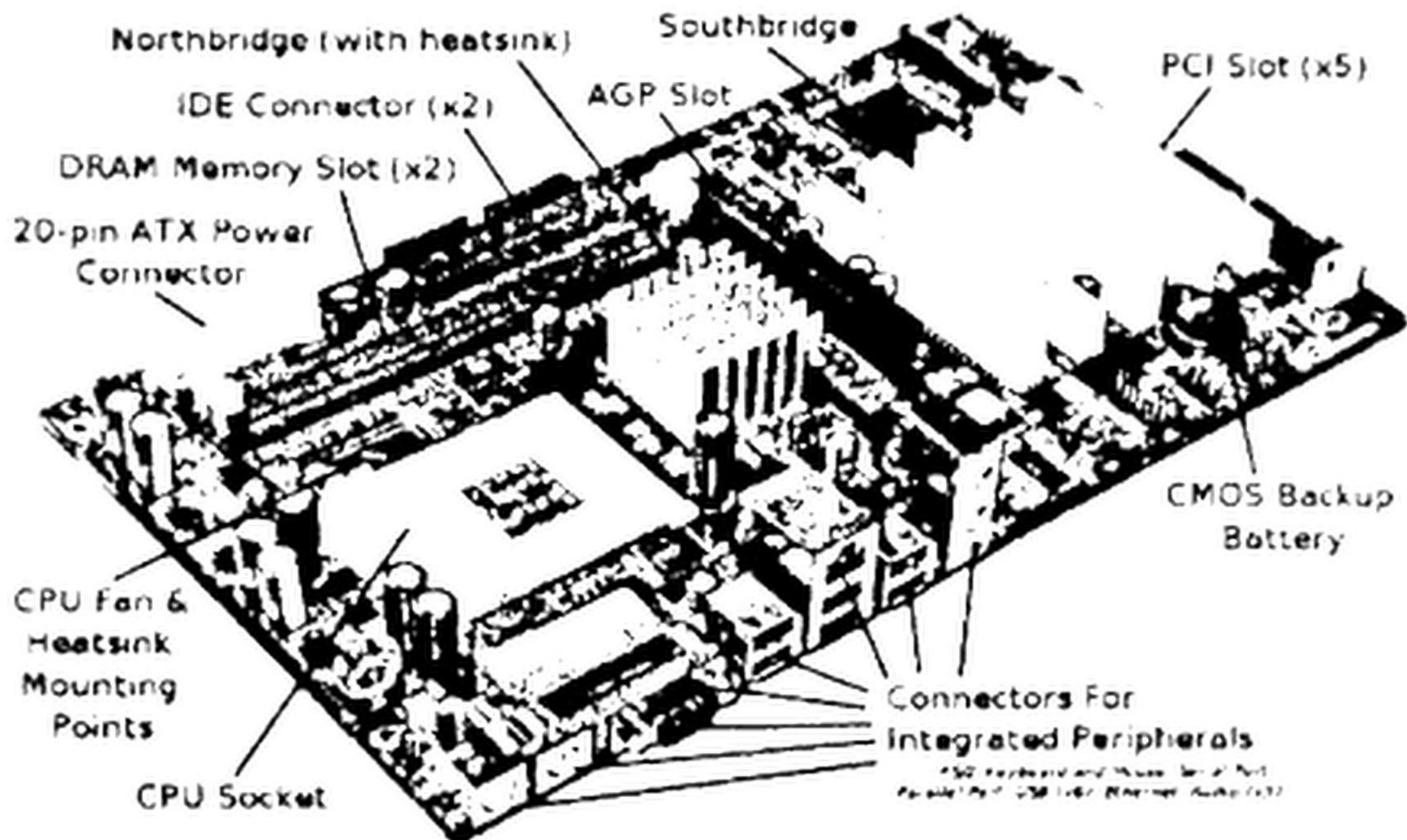

Q.37 Describe the working and structure of Microprocessor.

Ans: Microprocessor:

A microprocessor is the main chip on the motherboard that controls all the activities of the computer. It is also known as Central Processing Unit (CPU) or simply processor.

It contains Control Unit (CU), Arithmetic Logic Unit (ALU) and registers. A microprocessor and the block diagram of CPU are shown in Fig.

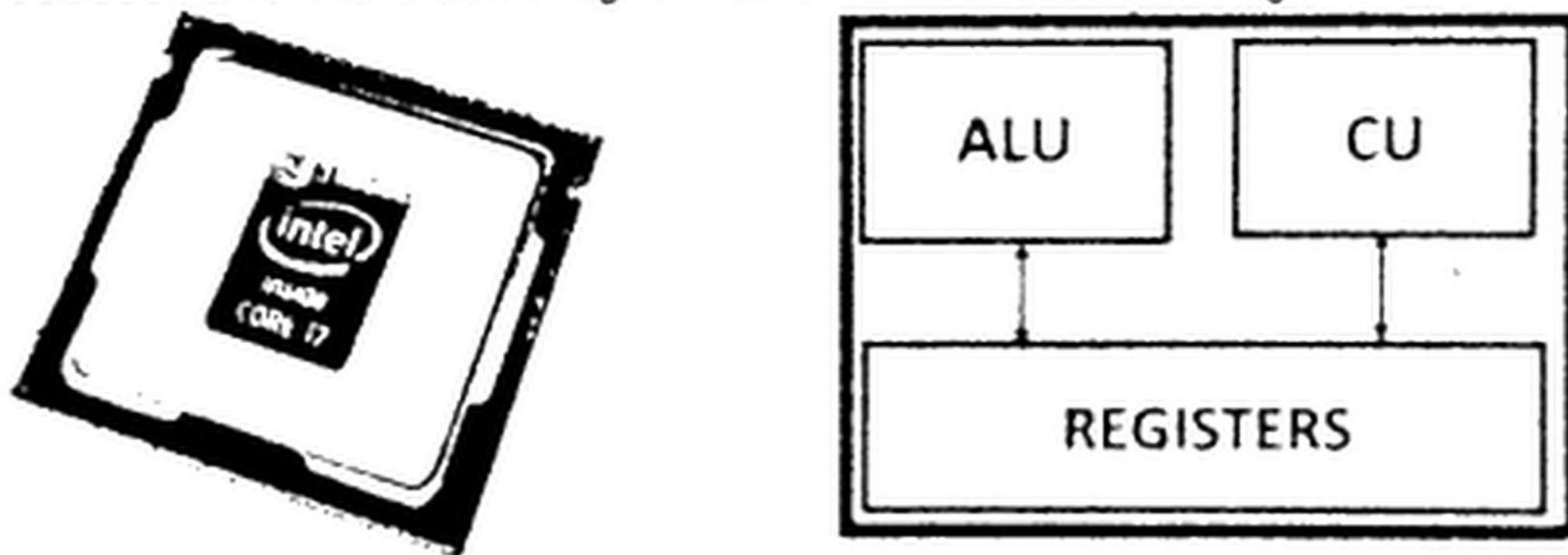

(a) Microprocessor (b) Block diagram of microprocessor

ALU:

ALU is the part of the computer that performs all the calculations and comparisons. It consists of arithmetic unit and logic unit.

Arithmetic Unit:

Arithmetic unit performs all the arithmetic operations such as addition, subtraction, multiplication and division.

Logic Unit:

Logic unit performs logical operations which include comparisons of numbers or alphabets.

loads programs into memory and executes them. It consists of very complicated circuits.

Q.38 Briefly write about Registers.

Ans: Registers:

Registers are small memory units inside the microprocessor used to temporarily store some information during the execution of a program. Some commonly used registers are Instruction Register, Accumulator Register, Data Register and Memory Address Register.

Q.39 Briefly write about storage devices.

Ans: Storage Devices:

Storage devices are used to store programs and data that are not currently used by the computer. They have huge storage capacity. Therefore, they are also known as mass storage devices or secondary memory.

Hard disk is the most commonly used storage device that is fixed inside the system unit. Portable storage devices are CD, DVD, memory cards and USB flash drive.

Portable storage devices have less storage capacity than hard disk but they are cheap and easy to carry.

Q.40 Briefly write about hard disk.

Ans: Hard disk:

A hard disk is a magnetic storage device used to store computer data. It has storage capacity of hundreds of Gigabyte (GB). It is fixed inside the computer casing. Portable hard disk is also available that is attached to USB port.

Q.41 Briefly write about CD/Compact Disk.

Ans: CD/ Compact Disk:

CD stands for Compact Disk. It is a portable optical storage device with a storage capacity of 700 Megabytes (MB). A CD is 1.2 millimeter thick with a diameter of 120 millimeters. CD drive is used to read data from or write data to a CD.

Q.42 Briefly write about DVD/Digital Versatile Disk.

Ans: DVD/ Digital Versatile Disk:

DVD stands for Digital Versatile Disk. It has the same thickness and diameter as CD but has more storage capacity. Its storage capacity is in the range of 4 to 16 GB. A DVD writer is installed in the computer to read data from or write data to a DVD. A CD can also be used in a DVD writer.

Q.43 Briefly write about Memory Card.

Ans: Memory Card:

Memory card is a small storage device having storage capacity of few Gigabytes. It is available in different sizes and storage capacities.



Memory cards are generally used in laptop computers and portable devices such as mobile phone and digital camera for storing pictures, audio and video. A memory card is shown in Fig..

Q.44 Briefly write about USB flash drive.

It is very fast in operation and its storage capacity is up to 128 GB till now. A USB flash drive is shown in Fig.



USB flash drive

Q.45 Write about the significance of output devices.

Ans: Output Devices:

Output devices are used to display text, graphics and images on the monitor or to print information on paper.

Softcopy and hardcopy/printout:

Information displayed on monitor is known as softcopy and anything printed on paper is known as hardcopy or printout.

Commonly used output devices are monitor, printer, plotter and speaker.

Q.46 Describe some features of different types of monitors.

Ans: Monitor:

It is an output device that has a screen on which information is displayed.

Types of Monitor:

It has two common types i.e. CRT (Cathode Ray Tube) monitor and LCD (Liquid Crystal Display) monitor.

CRT monitor:

CRT monitor is very similar to old television. It is almost obsolete due to its big size and low display quality.

LCD monitor:

LCD monitor is slim, uses less power and has better display quality than CRT monitor. CRT and LCD monitors are shown in Fig.

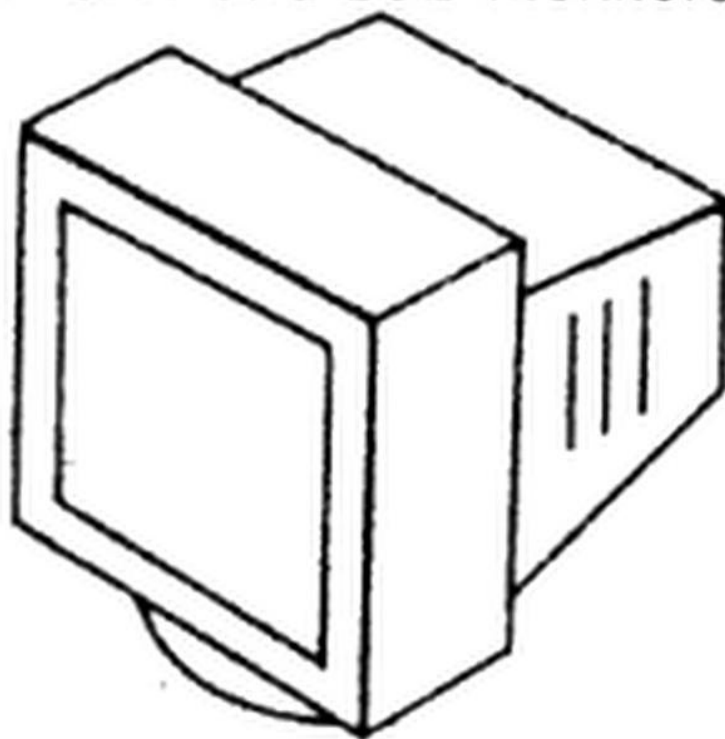

(a) CRT Monitor



(b) LCD Monitor

Q.47 What is printer. Write name of different types of printers.

Ans: Printer:

Printer is an output device that prints text and graphics on paper which is known as hardcopy.

Types printers:

For Your Information

The first high-speed printer was developed in 1953 by Remington Rand (an early American business machines manufacturer) for use on UNIVAC computer.

Q.48 What is an impact printer? How does it work? Describe the different features of Dot matrix printer.

Ans: Impact Printer:

Impact printer uses electro-mechanical mechanism which causes the character shape to strike against the paper and leave an image of the character on the paper

Features of Dot matrix printer:

Dot matrix printer is the most commonly used impact printer. The printing speed varies from 50 to 500 cps (characters per second)

Their printing is very cheap but print quality is poor. They produce lot of noise while printing

Uses of Dot matrix printer:

These printers are still in use for printing invoices, bank statements, utility bills, etc. A Dot matrix printer is shown in Fig.

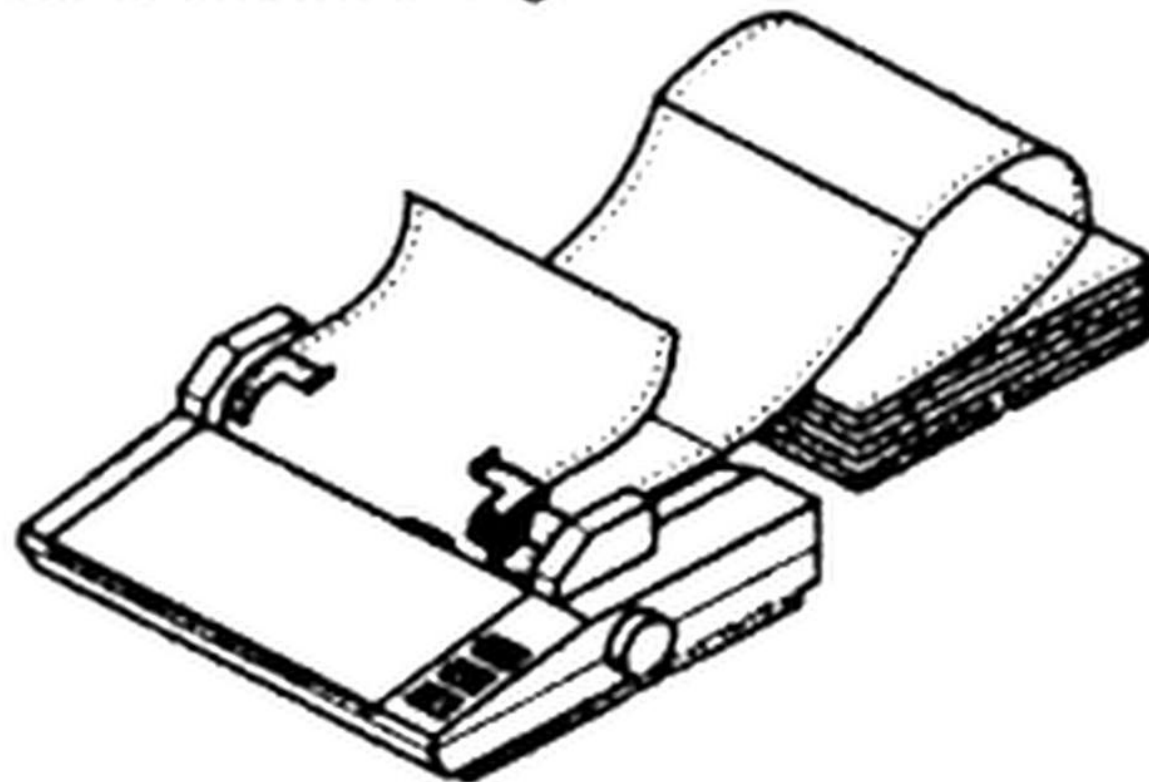

Dot Matrix Printer

Q.49 What is a non- impact printer? How does it work? Describe the different features of non-impact printer.

Ans: Non-Impact printer:

Non-Impact printer prints without striking the paper.

Types of non-Impact printers:

There are two types of non-Impact printers which are inkjet and laser printers.

Inkjet and laser printers:

Inkjet printer stores ink in cartridge and sprays on paper through fine nozzles on the print-head.

Inkjet and laser printers:

Laser printer uses technology similar to photocopying machine. Laser printer is more expensive, faster and has very high print quality compared to inkjet printer.



(a) Inkjet Printer

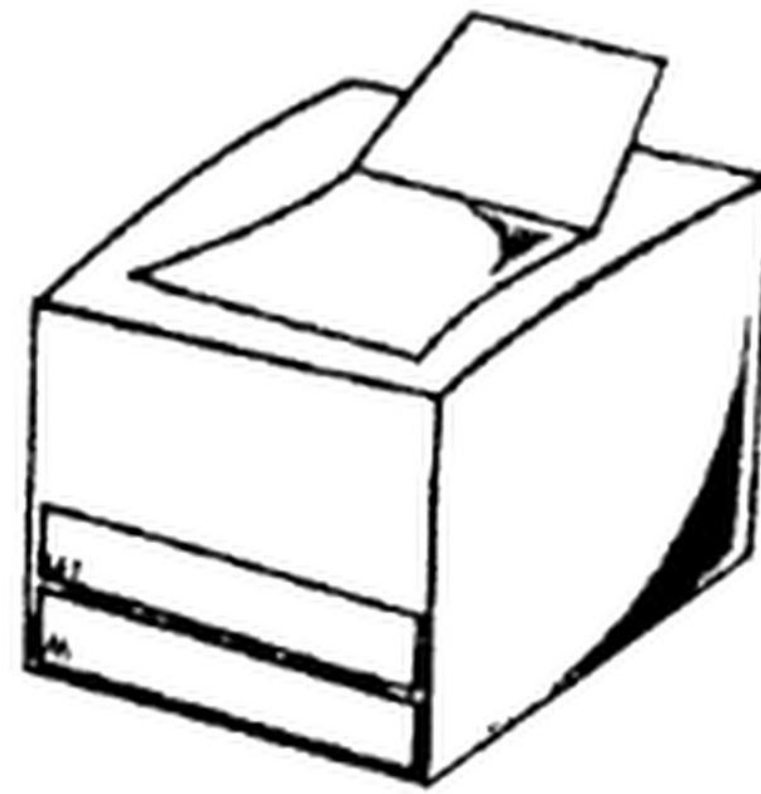

(b) Laser Printer

Q.50 What is a plotter? How does it work? Describe the different types of plotters.

Ans: Plotter:

Plotter is an output device used for printing engineering drawings, machine parts, building designs maps, charts and panaflexes etc on large size papers/sheets

Such large size printing is not possible on printers. It is more expensive than printer

Types of plotters:

There are two types of plotters, that is, ink plotter and pen plotter

Uses of plotters:

Ink plotter is used for printing images whereas pen plotter is used for printing engineering drawings, machine parts, building designs, etc. Plotter is a slow output device but its printing quality is good.

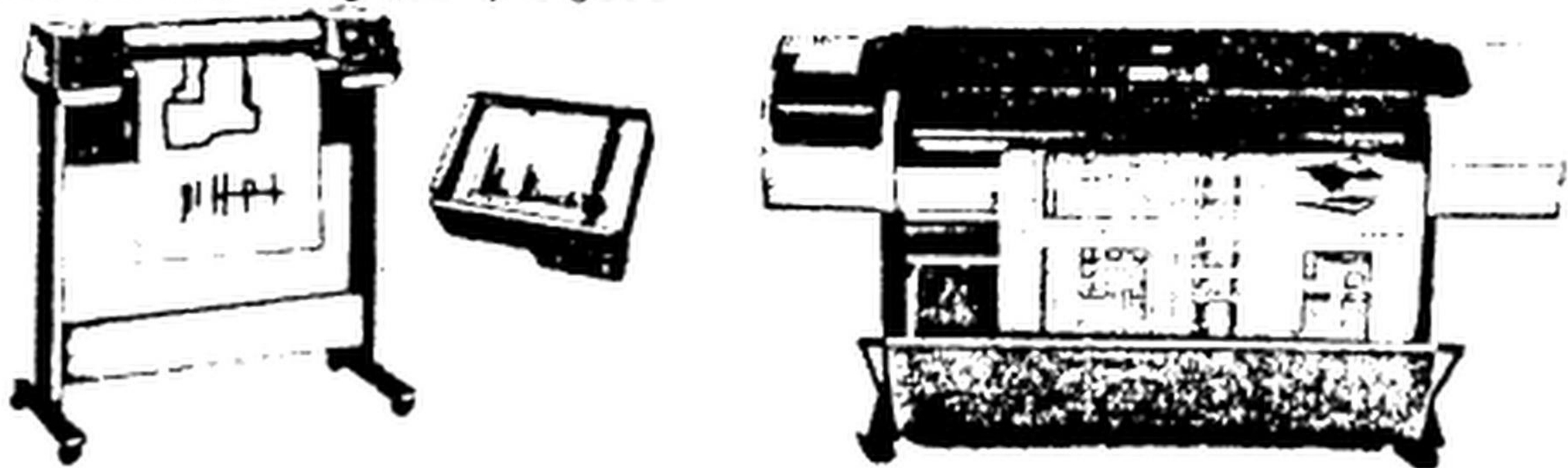

Plotter

Q.51 Describe some features of Speaker.

Ans: Speaker:

Speaker is a device used to produce audio output. A pair of speakers is attached to the sound card on the mot' erboard.

Speakers are commonly used with multimedia software and for playing music and videos on computer.



Q.52 List some functions of memory.

Ans: Memory:

Memory unit stores data and programs that are being executed by the computer. It also stores the results produced by the ALU after processing the data.

Types of memories:

There are three types of memories on the motherboard which are ROM (Read Only Memory) RAM (Random Access Memory) and Cache.

These are known as main memory or primary memory of computer.

Q.53 What is ROM? How do PROM and EPROM differ from each other?

Ans: ROM (Read Only Memory):

ROM is a single IC chip which is installed on the motherboard.

Types of memories:

It stores the Basic Input/output System (BIOS) of computer that controls input/output devices and the start-up or boot process.

BIOS programs:

BIOS programs test the computer's components when it is turned on and then load the operating system into the RAM to make the computer ready for operation.

BIOS programs are permanently stored in ROM when it is manufactured.

ROM is non-volatile memory:

ROM is non-volatile memory, that is, the programs stored in it are not lost when the computer is turned off.

Types of ROM:

There are three common types of ROM which are:

- i. **PROM** (Programmable ROM),
- ii. **EPROM** (Erasable Programmable ROM)
- iii. **EEPROM** (Electrically Erasable Programmable ROM).

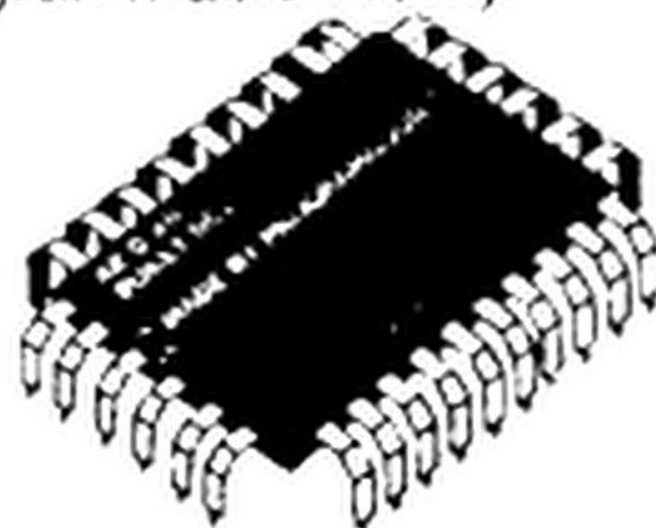
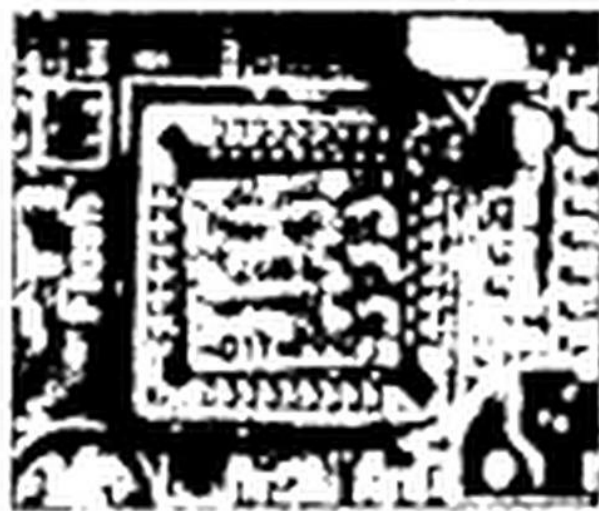

ROM Chip

Difference between PROM and EPROM:

PROM (Programmable Read Only Memory)	EPROM (Erasable and programmable Read Only Memory)
i. PROM is a non-permanent memory of a computer. It is programmable read only memory.	i. EPROM is a non-permanent memory of a computer. It is programmable and erasable read only memory.
ii. PROM is the Programmable ROM that allows the user to store	ii. EPROM (Electronic Programmable Read Only Memory) chips can be erased

iii. PROM (Programmable Read Only Memory) chips are relatively once written and to rewrite then you need to replace entire data on it. These are relatively less costly.

iii. On the other hand, an EPROM allows the data to be erased by the help of uv (Ultra violet) lights. i.e. EPROM is uv light erasable and electrically reprogrammable.

Q.54 What do you know about RAM?

Ans: Random Access Memory (RAM):

RAM is high speed memory installed on the motherboard. It is READ/WRITE memory. Information can be read from or written into it. Programs are loaded into RAM from secondary storage devices such as hard disk or USB flash drive for execution by the microprocessor.

Volatile memory:

RAM is volatile memory which means information stored in it, is lost when the computer is turned off.

RAM modules are installed in the memory slots on the motherboard. RAM modules are shown in Fig.



RAM Modules

Q.55 Describe various features of Cache Memory?

Ans: Cache Memory:

Cache is a very small amount of extremely fast memory inside the microprocessor or on the motherboard. It is faster and more expensive than RAM.

Function of cache:

Cache Memory stores information that is most frequently used by the computer.

Purpose of using cache:

The purpose of using cache is to improve the processing speed of computer.

Types of cache memories:

There are three types of cache memories which are: Level 1(L1), Level 2(L2) and Level 3(L3) as shown in Fig

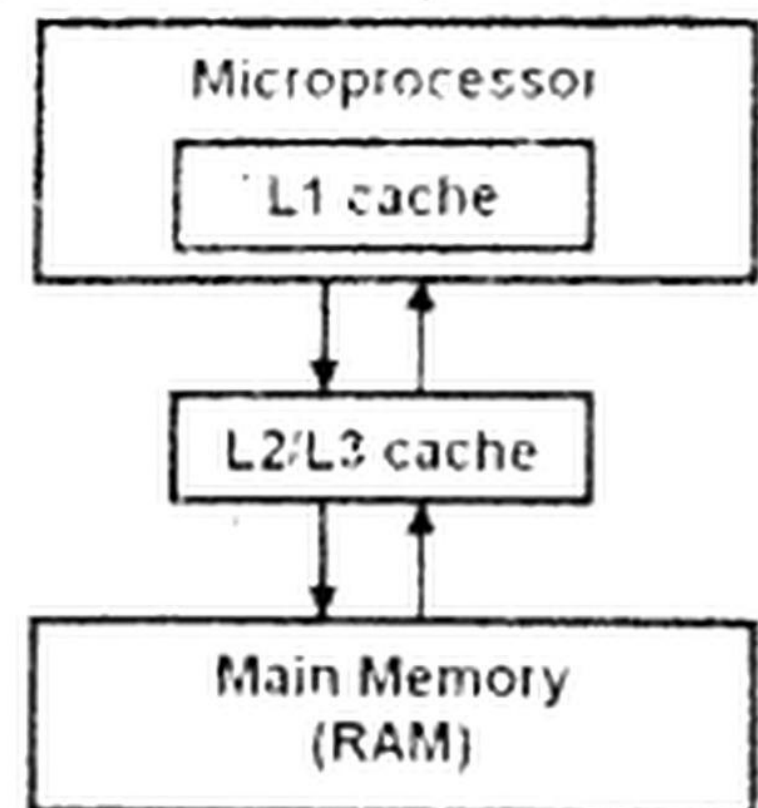

L1, L2 and L3 Cache Memories

Location of Level 1(L1), Level 2(L2) and Level 3(L3):

L1 cache is built inside the microprocessor whereas L2 and L3 are on the motherboard.

Note: L1 cache is faster than L2 and L3 cache.

Q.56 Describe the function of ports in a computer. How many types of ports are generally present in a computer system?

Function of Port:

A port provides a direct link for external peripheral devices such as keyboard, mouse, monitor, printer etc via cables with the computer's common electrical bus.

Types of ports:

There are various types of ports for connecting keyboard, mouse, monitor, microphone, speakers and other input/output devices as shown in Fig.

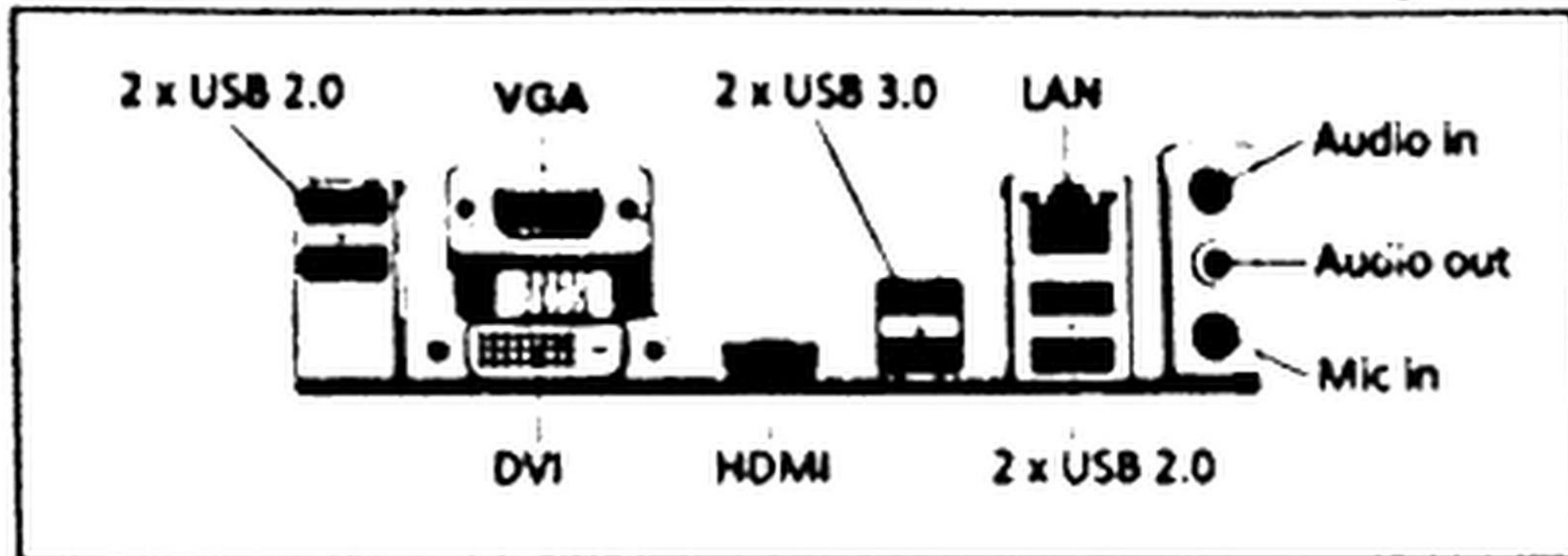

Ports on motherboard

In modern computers:

**USB (Universal Serial Bus),
HDMI (High Definition Multimedia Interface),
DVI (Digital Visual Interface),
Audio and LAN (Local Area Network) ports**

are used for connecting various devices to the computer. These devices include digital camera, scanner, printer, external hard disk or DVD writer and USB memory, etc

Q.57 Describe the function of expansion slots and expansion cards in a computer.

Ans: Expansion Slots:

Expansion slots are long narrow sockets on the motherboard used for installing expansion cards.

Expansion Cards:

Expansion cards are small circuit boards. These cards add new capabilities to the computers.

Commonly used expansion cards are sound card, graphics card, modem card and network card. In modern computers these cards are built-in on the motherboard. A network card is shown in Fig.

Q.58 What is computer software? List the main groups of computer software?

Ans. Computer Software:

Computer programs are known as computer software. Computer program is

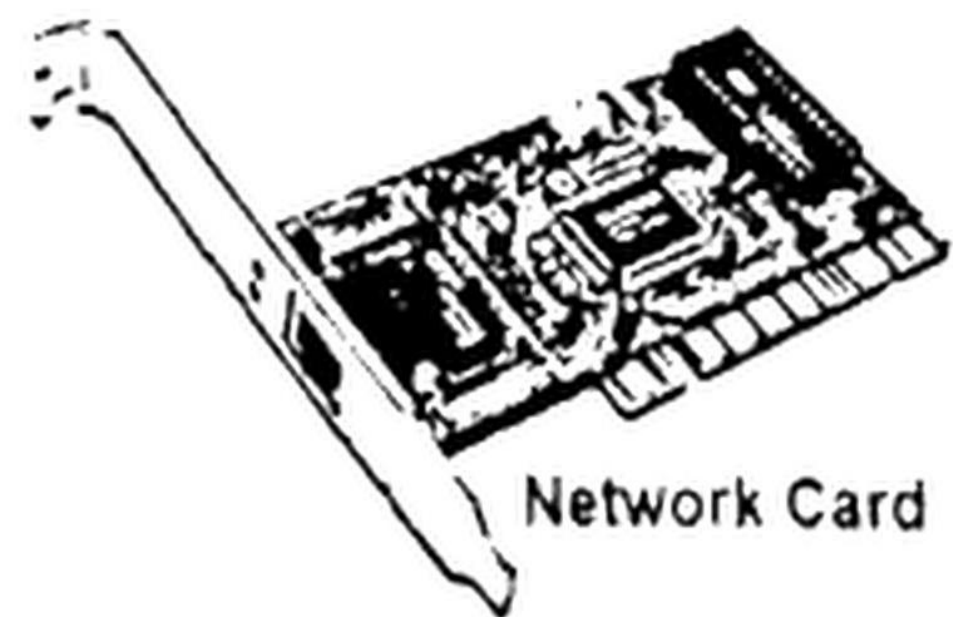

Network Card

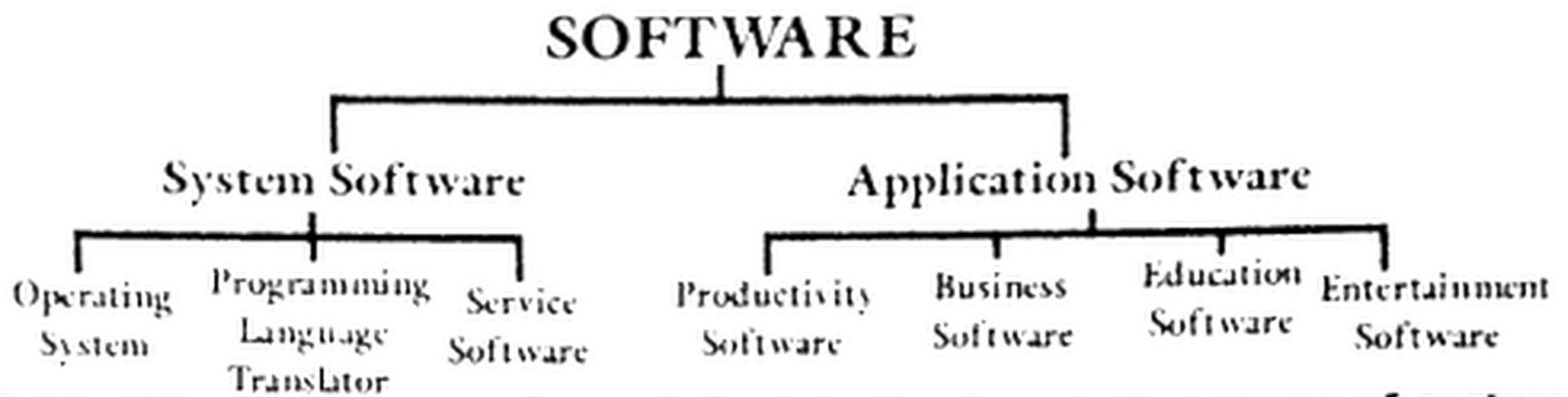

Q.59 What is system software? Explain the four main groups of system software?

Ans. System Software:

System software is a collection of programs which makes the use of computer easy and efficient. Highly experienced computer programmers develop system software.

Main groups of system software:

Following are the types of system software.

- Operating system
- Utility programs
- Device drivers
- Language processors

i. Operating System:

An operating system is system software that is responsible for the management and coordination of all the activities performed by the computer.

It provides the environment in which the user can interact with the computer hardware to operate the computer.

The most popular operating system used in microcomputers is the Windows.

Tasks performed by the operating system:

The following tasks are performed by the operating system.

- i.** It loads programs into memory and executes them.
- ii.** It controls the operation of input/output and storage devices.
- iii.** It manages files and folders.
- iv.** It allows to create password to protect computers from unauthorized use.
- v.** It detects hardware failures and displays messages to fix them.

ii. Device Drivers:

A device driver is system software that controls the operation of a computer device.

When users attach a device such as printer or scanner to their computer, they should install its driver also to make it operational. Device drivers are provided by device manufacturers.

iii. Utility Programs:

Utility programs perform specific tasks that are related to the management of the computer.

Commonly used utility programs:

The following are some commonly used utility programs that perform specific tasks.

Diagnostic utility: It is used to detect hardware and software problems.

Antivirus software: It is used to detect and remove viruses.

iv. Language Processors:

A language processor is a system program used to translate computer programs into machine language.

Machine language is directly understood by the computer. Therefore, all the programs must be translated into machine language before execution by the computer.

Compiler and interpreter:

Compiler and interpreter are language processors used to translate high level language programs into machine language.

Assembler:

A program called assembler is used to translate assembly language programs into machine language.

Q.60 What is application software? List the main groups of computer software?

Ans. Application Software:

Application software is developed for computer users to solve their problems such as preparing a letter, creating a presentation or managing a database.

Main groups of application software:

Commonly used application software includes productivity software, business software, entertainment software and education software.

Q.61 Elaborate open source software, shareware and freeware.

Ans. i. Open Source Software:

It is computer software that is available in the form of source code that allows users to study, change and improve it. Open source software is free for use, modification and distribution.

Examples of open source software:

Some examples of open source software are Linux operating system, Open Office (office productivity software), Flight Gear (flight simulator) and Java programming language, etc.

ii. Shareware:

Shareware is distributed free of cost for a limited period, usually one or two months. It is trial version of software given to people to decide whether they would like to buy the full version of the software.

Some shareware is installed on new computers when they are sold.

Examples of shareware:

Examples of shareware are antivirus software and computer games, etc.

ii. Freeware:

Freeware is given free of cost and it is full version of software for an unlimited period of time. It may have some restrictions such as allowed for personal or academic use only.

Examples of freeware:

KEY POINTS

- Computer is a general-purpose programmable machine that has the ability to store, retrieve and process data that is represented in the form of 0s and 1s.
- First generation computers used vacuum tubes and their period was from 1940 to 1956.
- Second generation computers used transistors and their period was from 1956 to 1963.
- Third generation computers used IC chips that were developed in early 1960s and their period is from 1963 to 1971.
- Fourth generation computers use LSI and VLSI chips and their period is from 1971 to present.
- Fifth generation of computers is concerned with development of devices that can understand natural languages and have thinking power.
- Analog computer represents and processes data by measuring quantities such as voltage and current to solve a problem. It works on supply of continuous signals as input and displays output simultaneously.
- Digital computer works with binary digits 0 and 1. Data and instructions are fed into digital computer through an input device such as keyboard. The computer performs calculations on data according to the instructions and displays results on monitor or prints on printer.
- Hybrid computer is a combination of analog and digital computers. It combines the characteristics of both analog and digital computers.
- Mainframe computer is a very large, very powerful and expensive computer that can support hundreds and even thousands of users at the same time.
- Minicomputer is bigger than microcomputer but smaller than mainframe. It is used in organizations that have hundreds of users.
- Microcomputer is the smallest and the low cost computer. It is the most commonly used computer in homes and offices.
- Software engineer is a highly skilled person in the field of IT whose responsibilities involve the analysis, design, implementation and maintenance of computer software.
- Computer programmer is an IT professional who has extensive knowledge and expertise in programming languages. He programs the computer by writing step-by-step instructions that tell the computer what to do.
- System analyst analyzes the data processing requirements of organizations and develops information systems to implement them.
- Hardware engineer is an IT professional who designs and manufactures computer hardware.
- Network engineer is a person who is responsible for installation, configuration and maintenance of computer networks in organizations.
- Database administrator is a person who is responsible for the maintenance

- Multimedia designer is a person who designs multimedia software by combining text, graphics, animation, audio and video
- Information security analyst is a person whose job is to protect information and information systems from unauthorized access, use, modification, recording and destruction.
- Computer teacher is a person who teaches the subject of computer science to students
- Computer hardware refers to the physical components that make up a computer system
- Computer software is a set of instructions that tells a computer what to do and how to do
- System software is a collection of programs which makes the use of computer easy and efficient
- Operating system is system software that is responsible for the management and coordination of all the activities performed by the computer
- Application software is developed to solve the problems of computer users such as writing letter, creating presentation or managing a database.
- Open source software is a program that is freely available in the form of source code that allows users to study, change and improve it.
- Shareware is trial version of software that is distributed free of cost for a limited period, usually one or two months
- Freeware is software given free of cost for an unlimited period of time

EXERCISE

Q1. Select the best answer for the following MCQs.

i. Who invented logarithm?

- | | |
|--------------------|---------------------|
| A. Blaise Pascal | B. John Napier |
| C. Charles Babbage | D. Herman Hollerith |

ii. Which generation of computer used transistor?

- | | |
|--|--|
| A. 1 st Generation of Computers | B. 2 nd Generation of Computers |
| C. 3 rd Generation of Computers | D. 4 th Generation of Computers |

iii. In which generation of computer microprocessor was introduced?

- | | |
|--|--|
| A. 1 st Generation of Computers | B. 2 nd Generation of Computers |
| C. 3 rd Generation of Computers | D. 4 th Generation of Computers |

iv. Which of the following computer supports thousands of users at the same time?

- | | |
|-----------------------|--------------------|
| A. Microcomputer | B. Minicomputer |
| C. Mainframe computer | C. Laptop computer |

v. Who is responsible for protecting information and information systems from unauthorized people in an organization?

- | | |
|-------------------|---------------------------------|
| A. System Analyst | B. Information Security Analyst |
|-------------------|---------------------------------|



Ruff.pk ek educational platform hai jahan students ke liye Notes, Guess Papers, Past Papers, Pairing Schemes, MCQs, Important Questions, Solved Exercises aur PDF Study Material available hai. Hum students ko board exams aur test preparation ke liye easy aur helpful content provide karte hain.

Ruff.pk par aapko class-wise study material, exam updates, educational news, admission information aur smart study resources ek hi jagah milte hain taake aap apni preparation behtar tareeqe se kar saken.

 Notes |  Guess Papers |  Past Papers |  MCQs |  Pairing Schemes |  PDF Notes
| Exam Preparation

 <https://ruff.pk>

 *Learn Smart, Prepare Better*

Visit : <https://ruff.pk>